

## Knipdieren en origami dieren

Zoals je in de handleiding van het spel kon lezen, gaan de kinderen al knutselend aan de slag met een dier uit hun categorie. Afhankelijk van leeftijd en vaardigheden van de kinderen kan je kiezen voor een ‘knipdier’ of ‘origamidier’. Voor iedere categorie is er één knipdier en één origami dier. De knipdieren zijn in de regel makkelijker te maken dan de origami versies.

In dit pdf-bestand vind je alle 20 dieren en een extra blad met uitknipbare extra elementen zoals vb. een staart van een kat. De pdf kan bij jou in de bib of de klas gewoon afgeprint worden. Hieronder volgen enkele praktische tips voor dat afdrucken:

### Knipdieren

- De knipdieren in deze pdf zijn op ware grootte opgemaakt. De verschillende elementen kunnen uitgeknipt en eenvoudig gevouwen worden. Met wat lijm worden de afzonderlijke delen aan elkaar bevestigd.
- Voor de knipdieren adviseren we een dikker papier voor een mooier eindresultaat. Vraag in de papier- of kopiewinkel in de buurt naar een papier van 120 tot 140 gram.
- Test wel eerst jouw printer hoe zwaar het papier mag zijn voor een optimaal printresultaat. Lukt het niet met dikker papier, neem dan papier van 100 gram, dat is meestal nog iets steviger dan het normale printpapier.
- Een andere optie is om een digitale drukopdracht te geven in de kopiewinkel in de buurt. Bezorg hen het pdf-bestand, omschrijf het papier dat je wenst en zij doen de rest.

### Origami dieren

- De origami dieren zijn opgevat volgens de traditionele origami-techniek. Dat wil zeggen dat je telkens start met een vierkant stukje papier, meestal 15 x 15 cm. Een enkele keer is het papier 10 x 10 cm. De afmetingen staan telkens bij de eerste stap van de vouwopdracht.
- Vouwen met origami doe je best met een dun papier, dunner dan het papier dat je gebruikt om te printen. Je vindt dit typische origami-papier bij de papierwinkel in de buurt (Ava, De banier ...).
- Uit dit papier snijd je (of de kinderen) basisvierkanten van 15 x 15 cm. Voor één opdracht heb je een beginvorm van 10 x 10 cm nodig. Dan ben je klaar om de origami opdracht uit te voeren.

### Vouwen

- De vouwstappen staan nauwkeurig beschreven of worden visueel aangeduid met pijltjes. Wanneer dit nog te moeilijk is voor sommige kinderen, kan je hen ook de instructieflimpjes laten zien die op de website van de Jeugdboekenweek staan. De kinderen zien daar audiovisueel hoe ieder origami dier gevouwen kan worden.

### Printtip

- Bij het afprinten van de pdf staat de basisprinterinstelling “page scaling” veelal ingesteld op “fit to printable area”. Dat maakt dat je print ietwat verkleind afgedrukt wordt. Als je deze optie op “none” instelt, neemt je print de maximaal beschikbare ruimte op een A4 in.

*Veel plezier!*

De origami's komen uit deze boeken:

– *Het grote vouwboek (dl. 1-6)*, Thea Van Mierlo, Cantecler, 2002

– *Origami express, reis om de wereld in 40 vouwprojecten*, Van Sicklen Margaret, Forte, 2010

De kleefdieren: © Vec-star.

# Kriebeldieren – Kip Origami

Losse uitknipelementen: zie pag 22

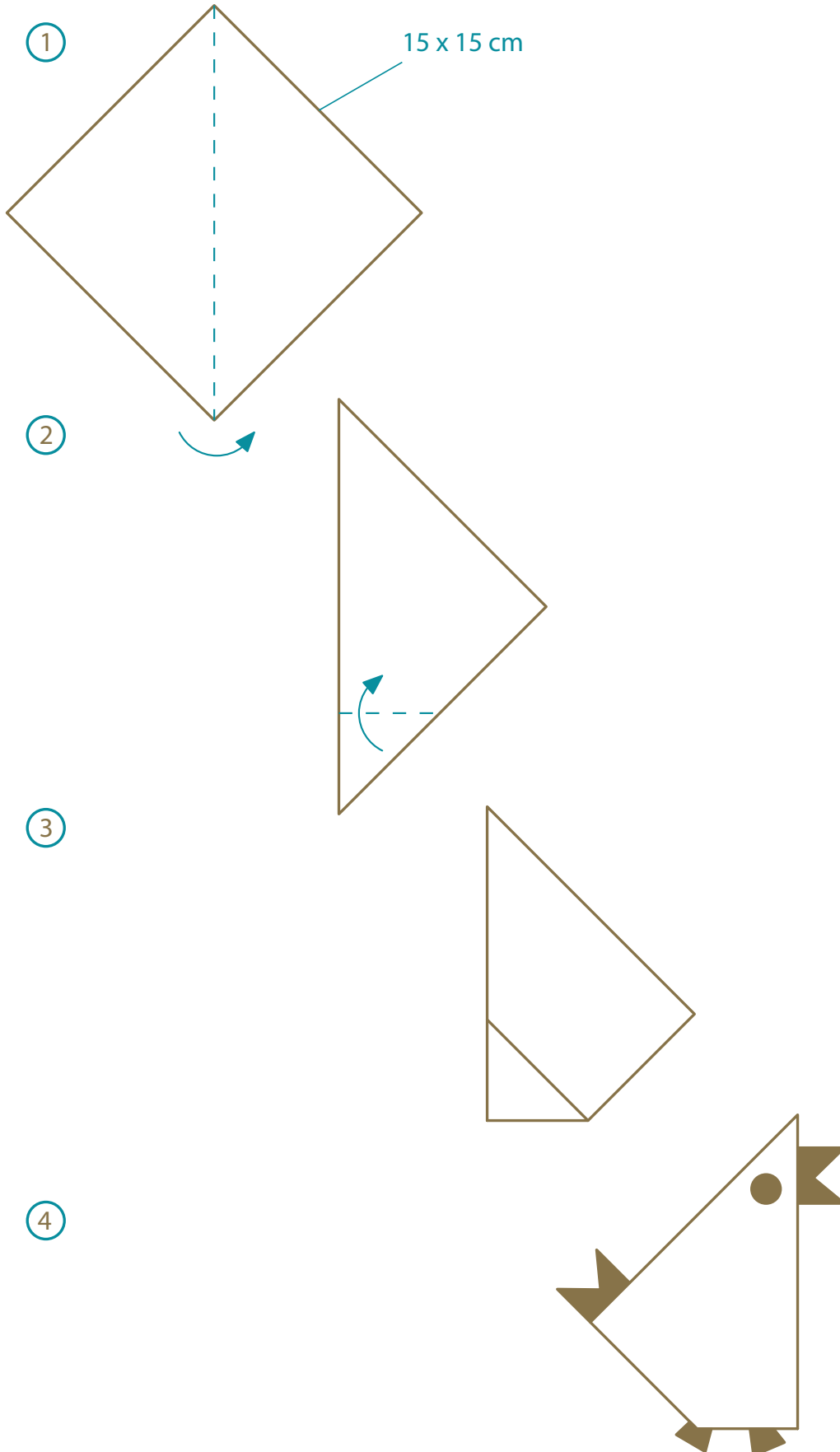

## Kriebeldieren – Kip Knip

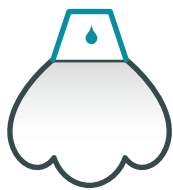
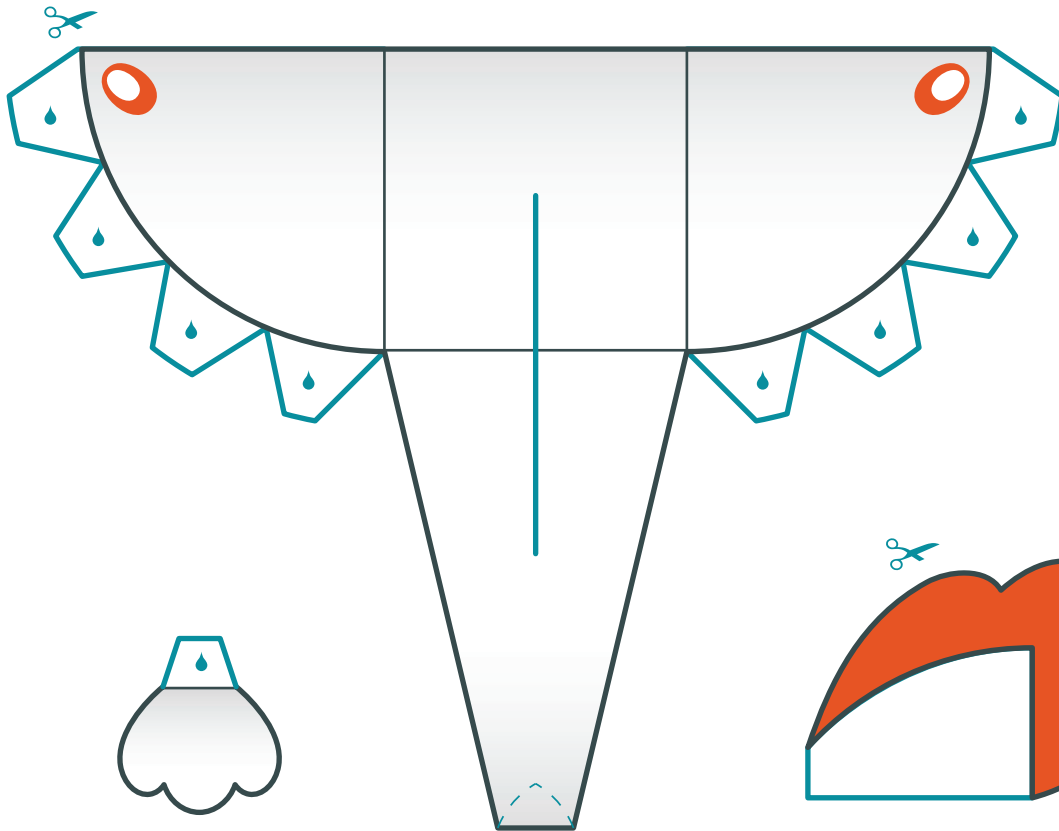
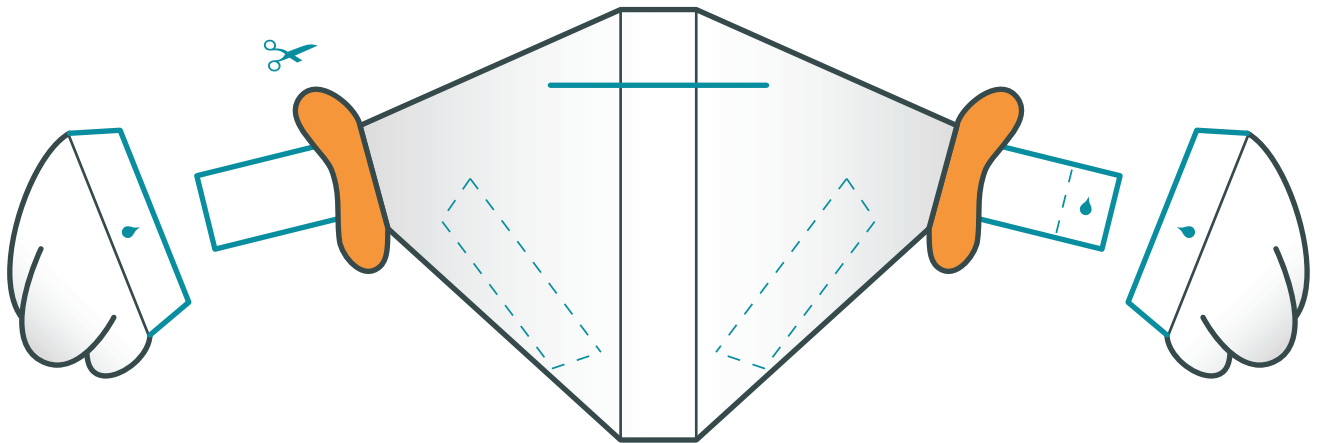
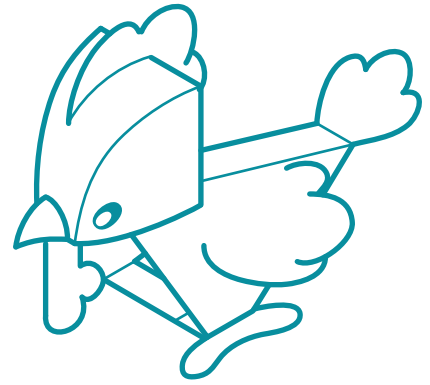

## Glibberige dieren – Walvis Origami

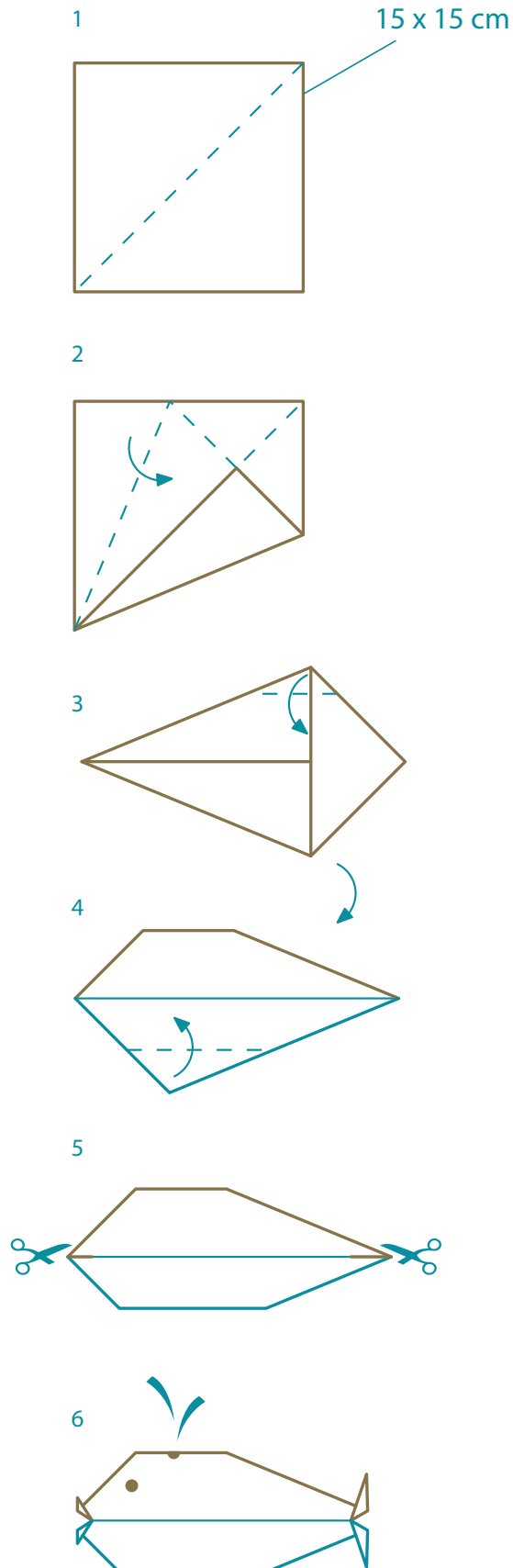

## Glibberige dieren – Slang Knip

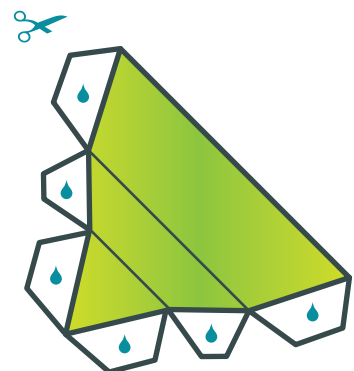
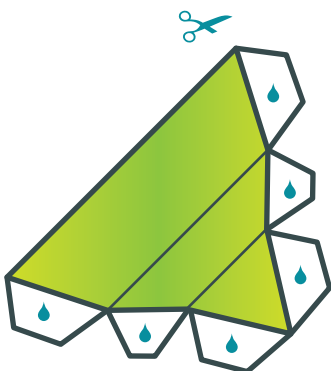
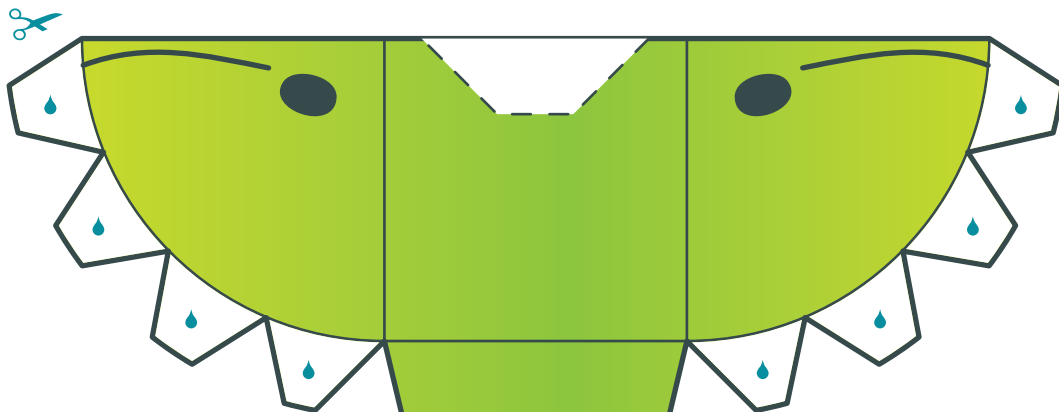
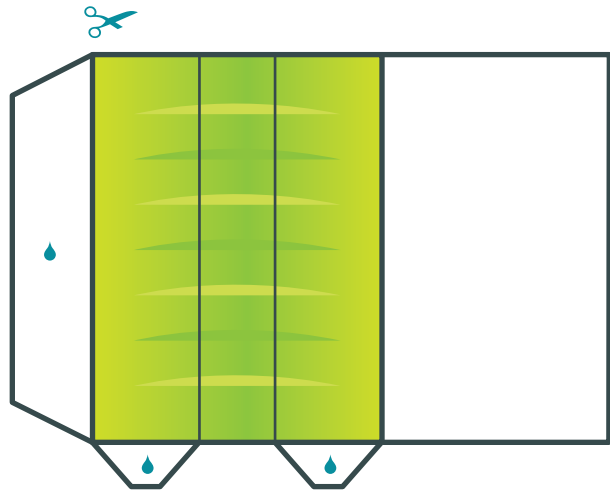
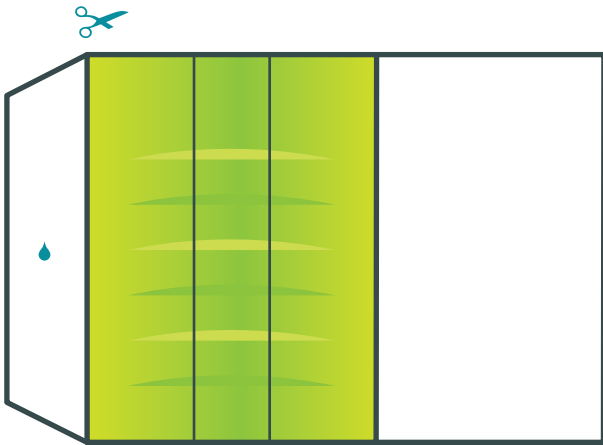
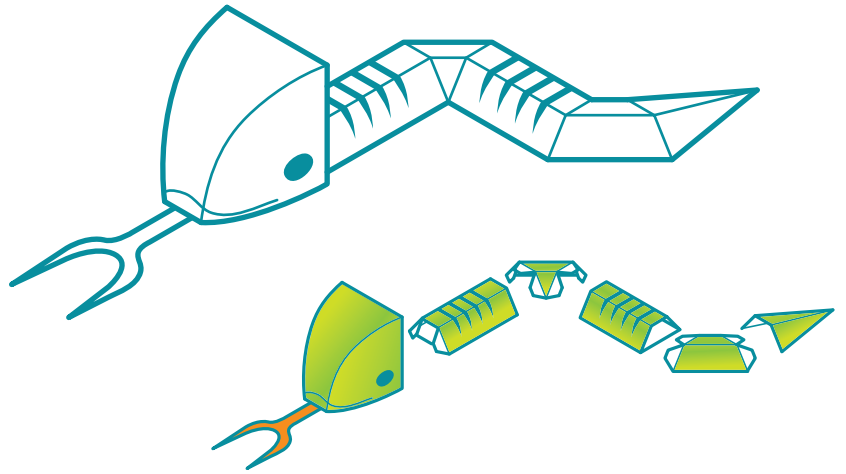
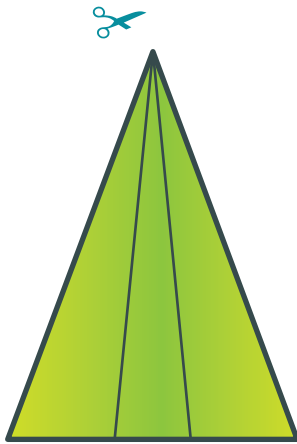

① 1 lijf

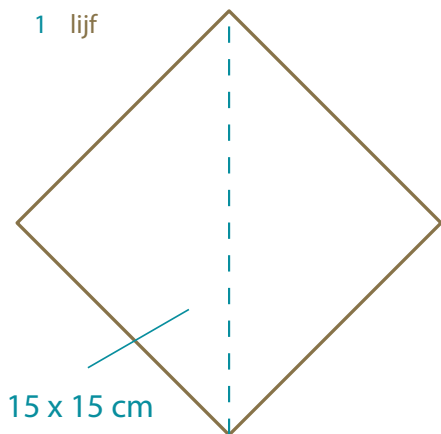

2

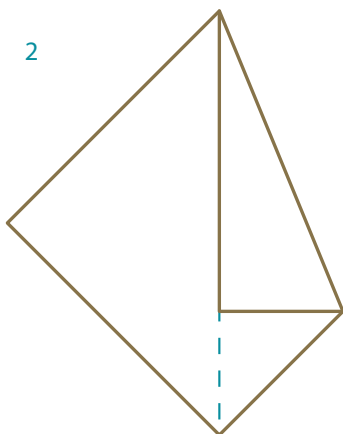

3

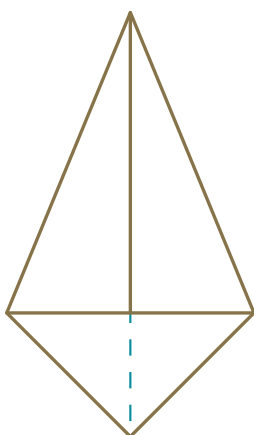

4

5

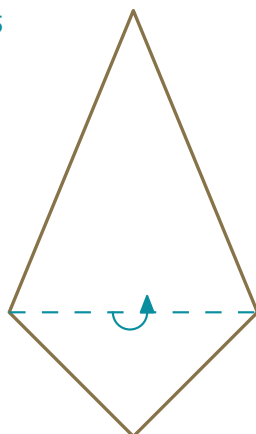

6

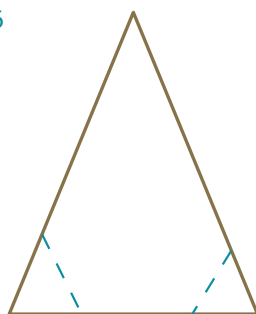

7

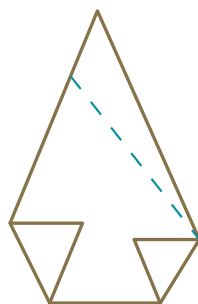

8

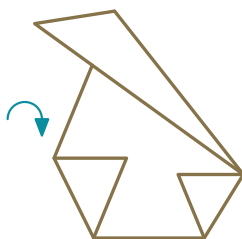

② 1 veren

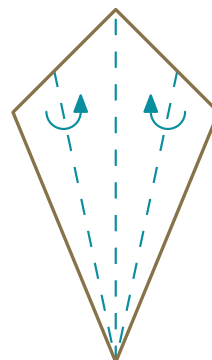

2



3

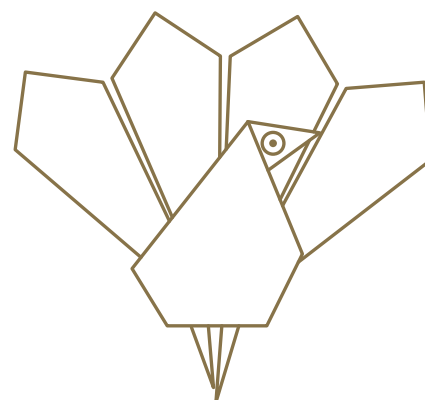

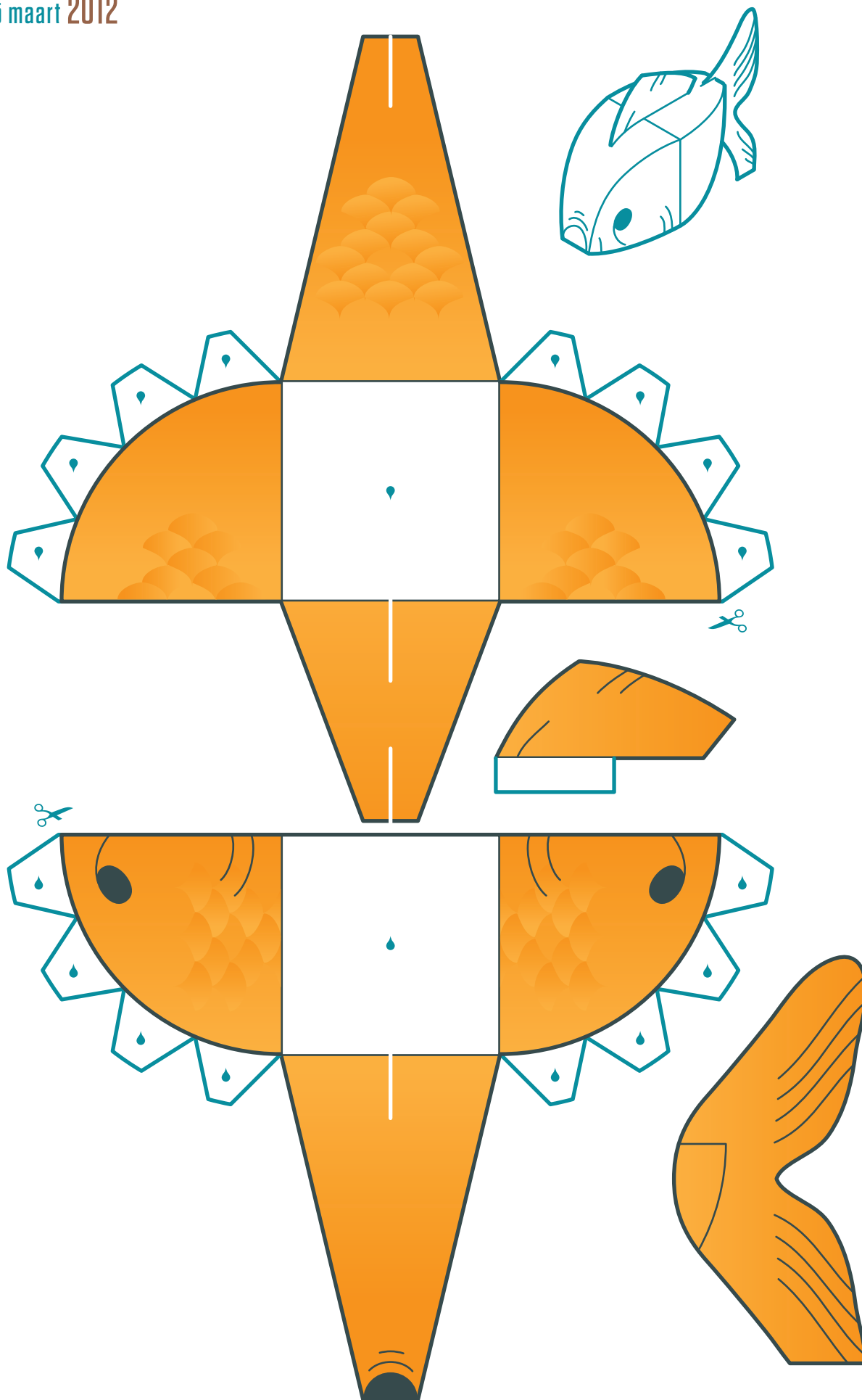



# Donkere dieren – Kat Origami

Losse uitknipelementen: zie pag 22

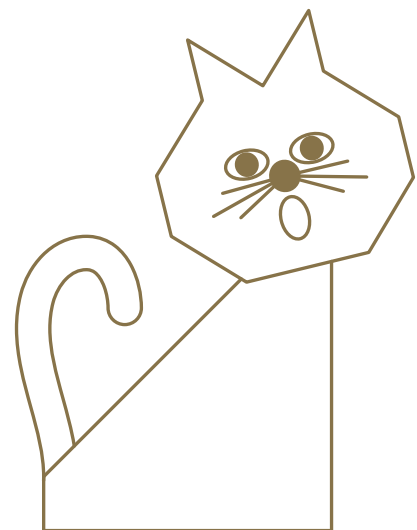
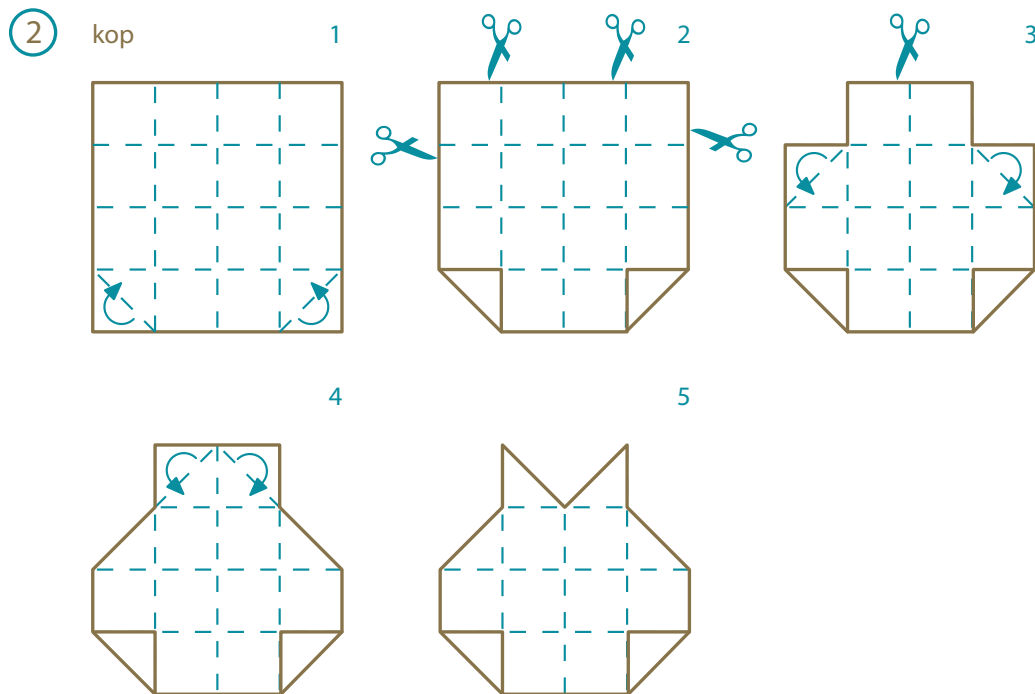
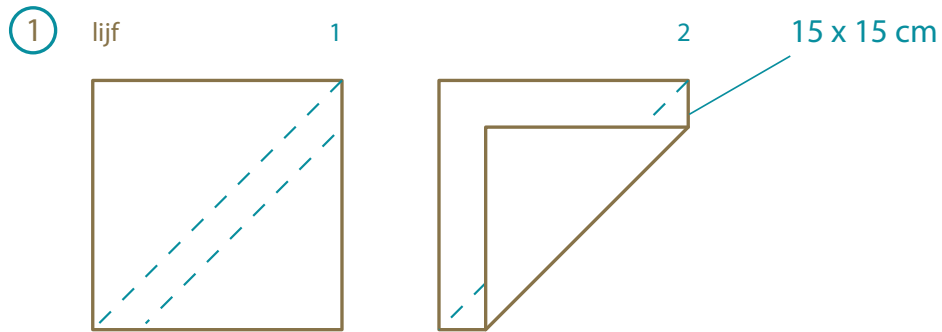

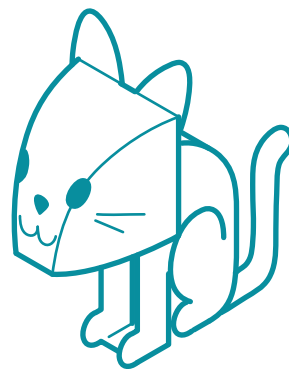

## Donkere dieren – Kat Knip

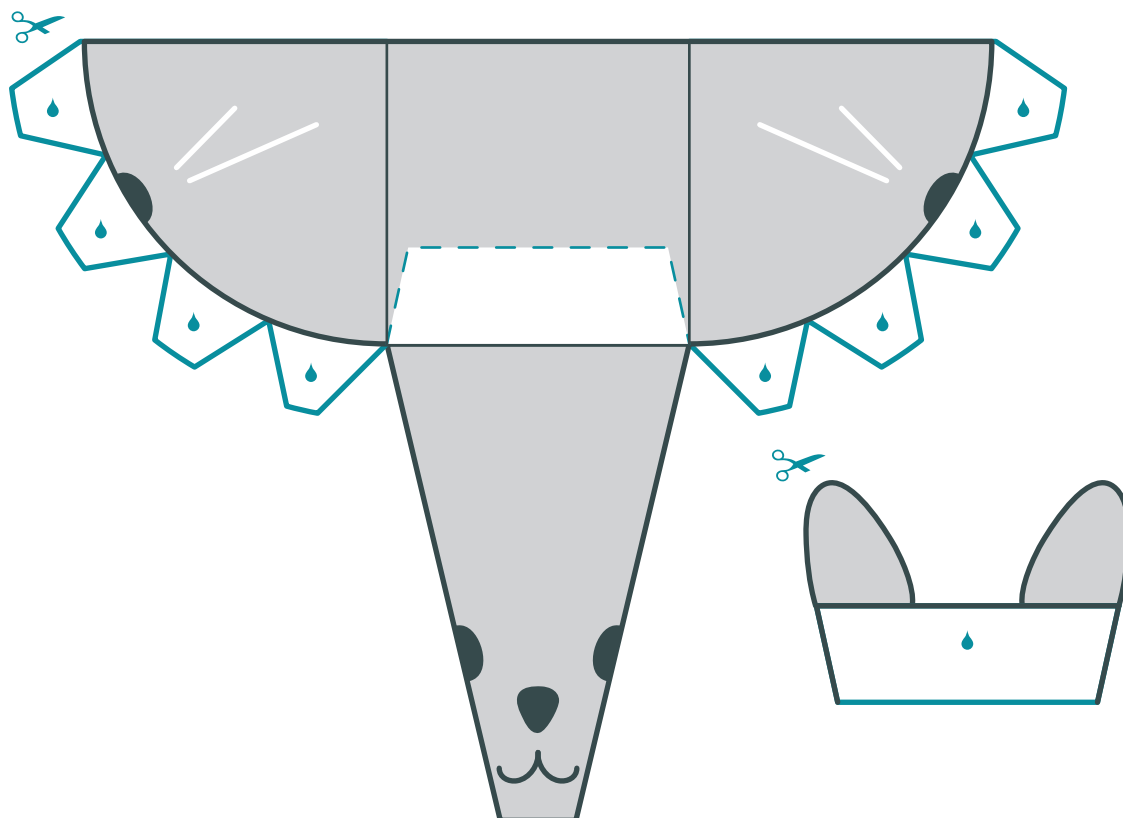
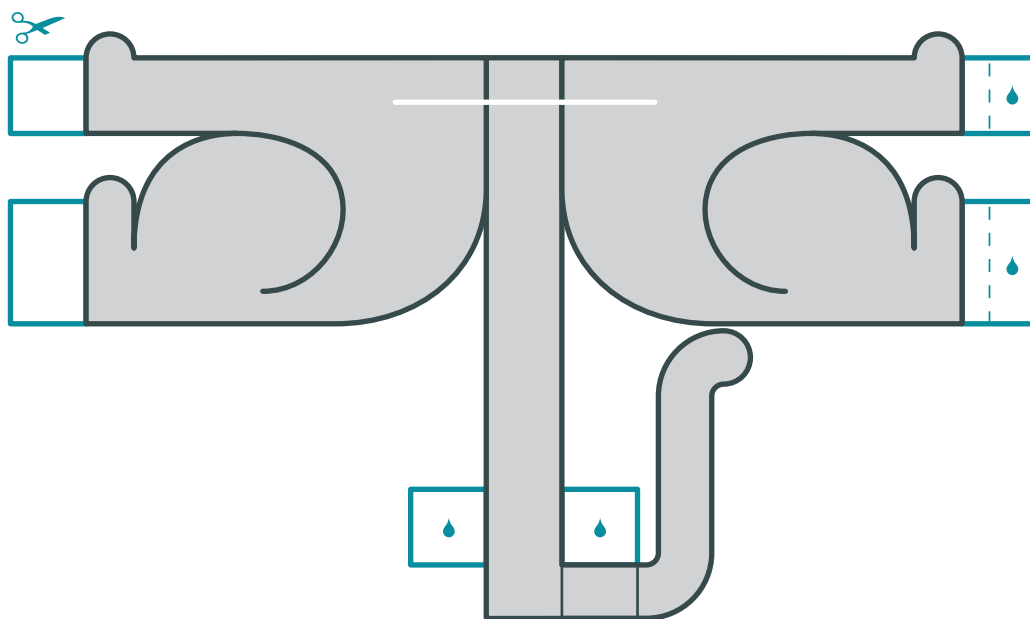



# Rare Vogels – Pinguïn Origami

Losse uitknipelementen: zie pag 22

① onderlijf 1

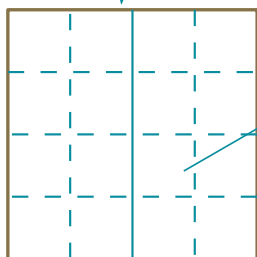

15 x 15 cm

② bovenlijf 1

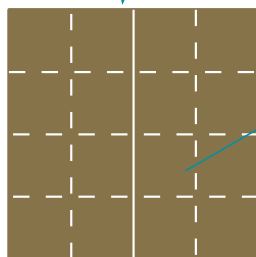

15 x 15 cm

2

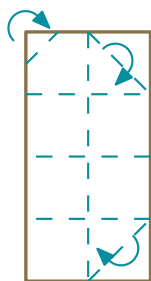

2



3



3



4



4

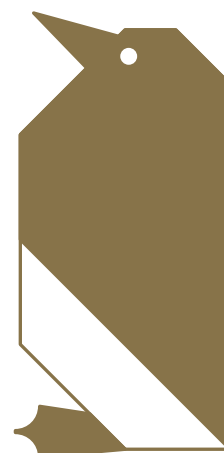

## Rare Vogels – Vleermuis Knip

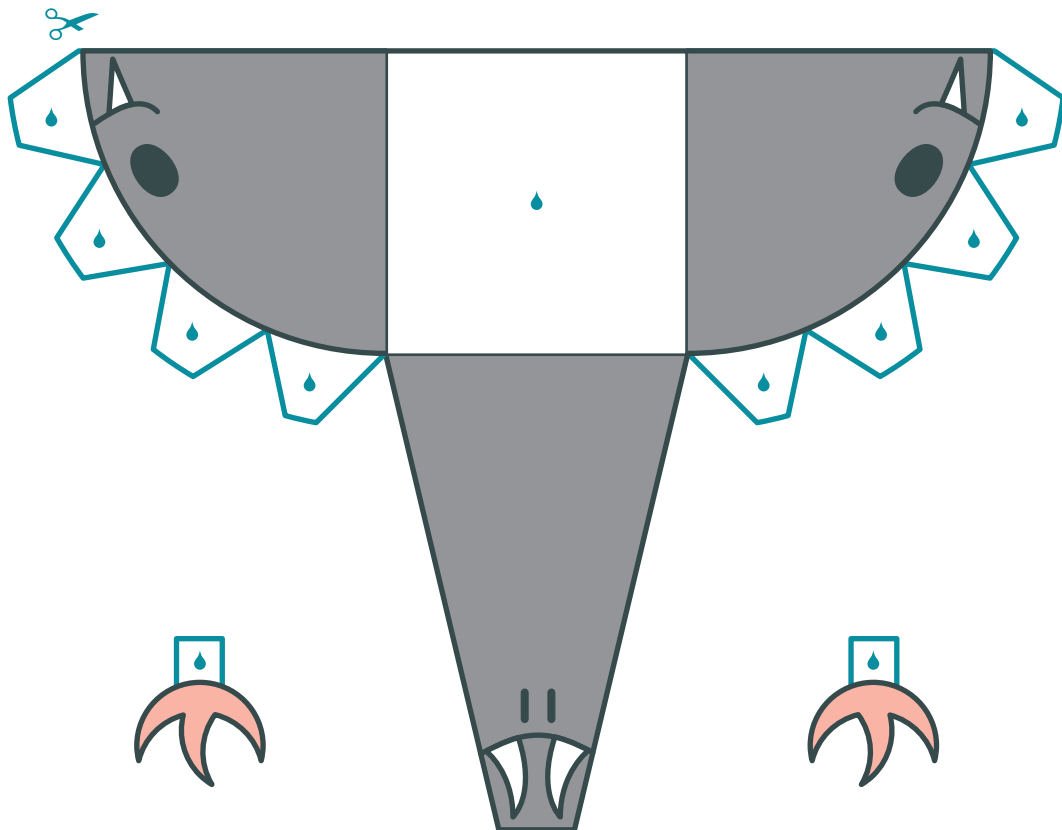
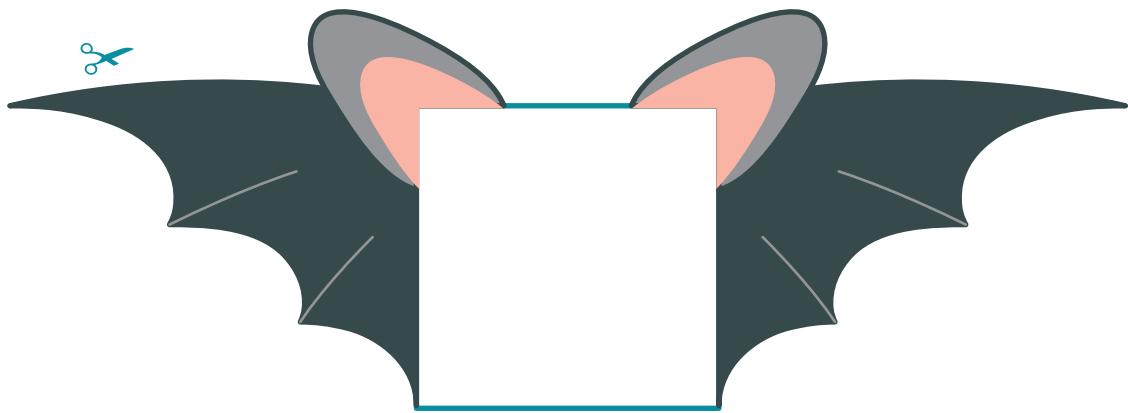



# Acrobaten – Slak Origami

Losse uitknipelementen: zie pag 22

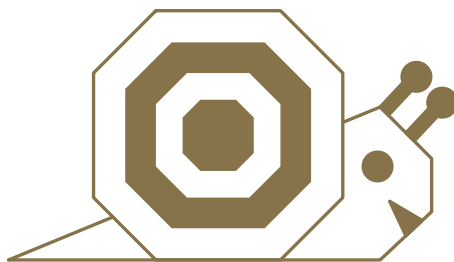
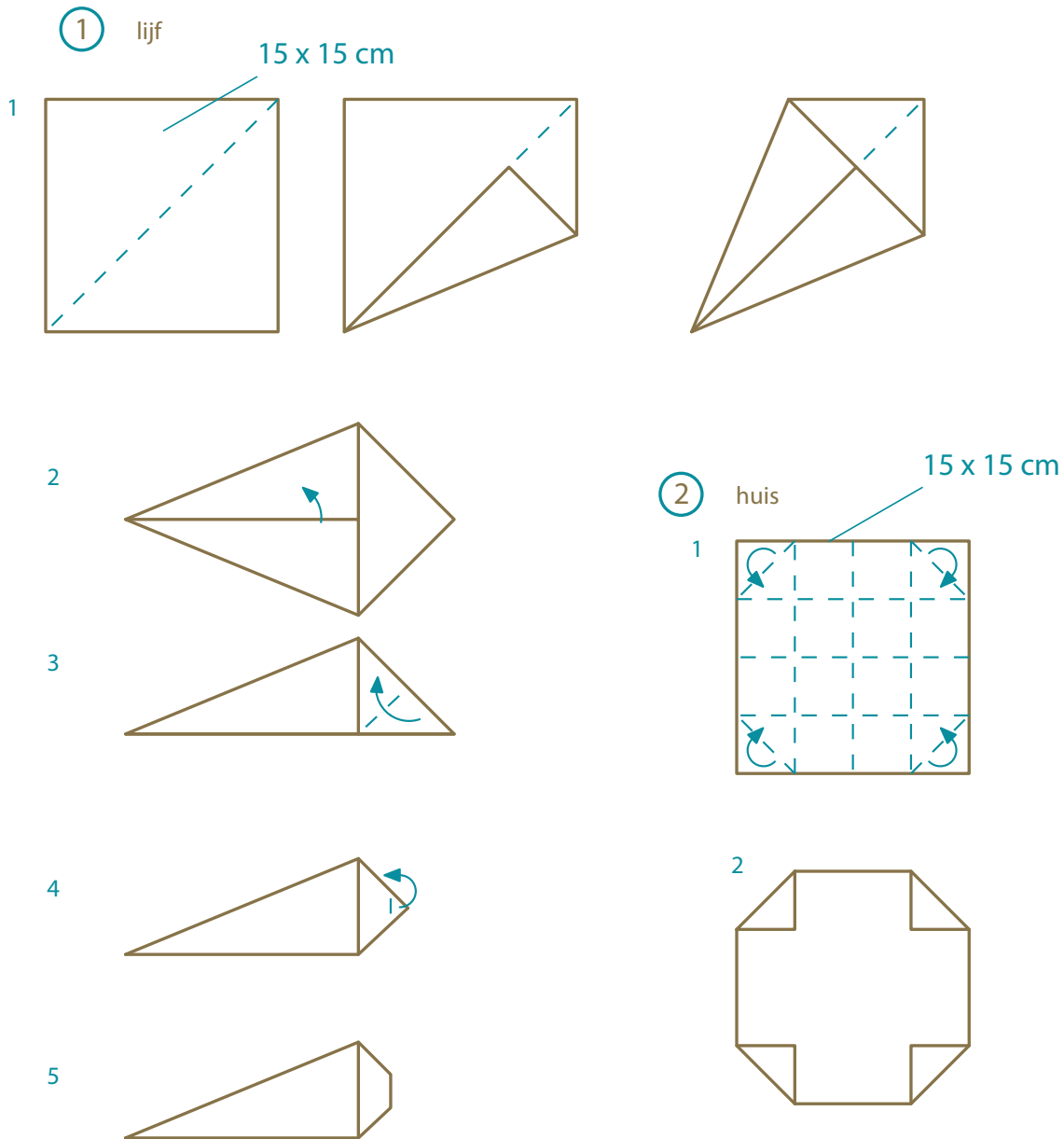

## Acrobaten – Giraf Knip

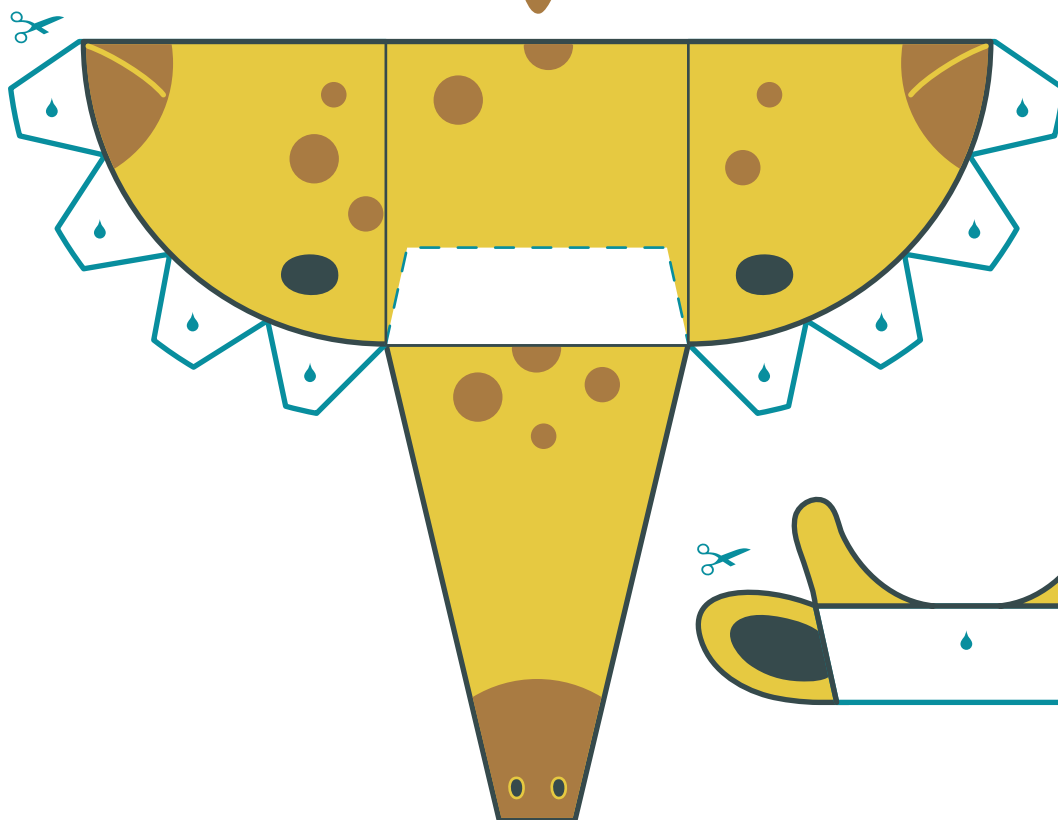
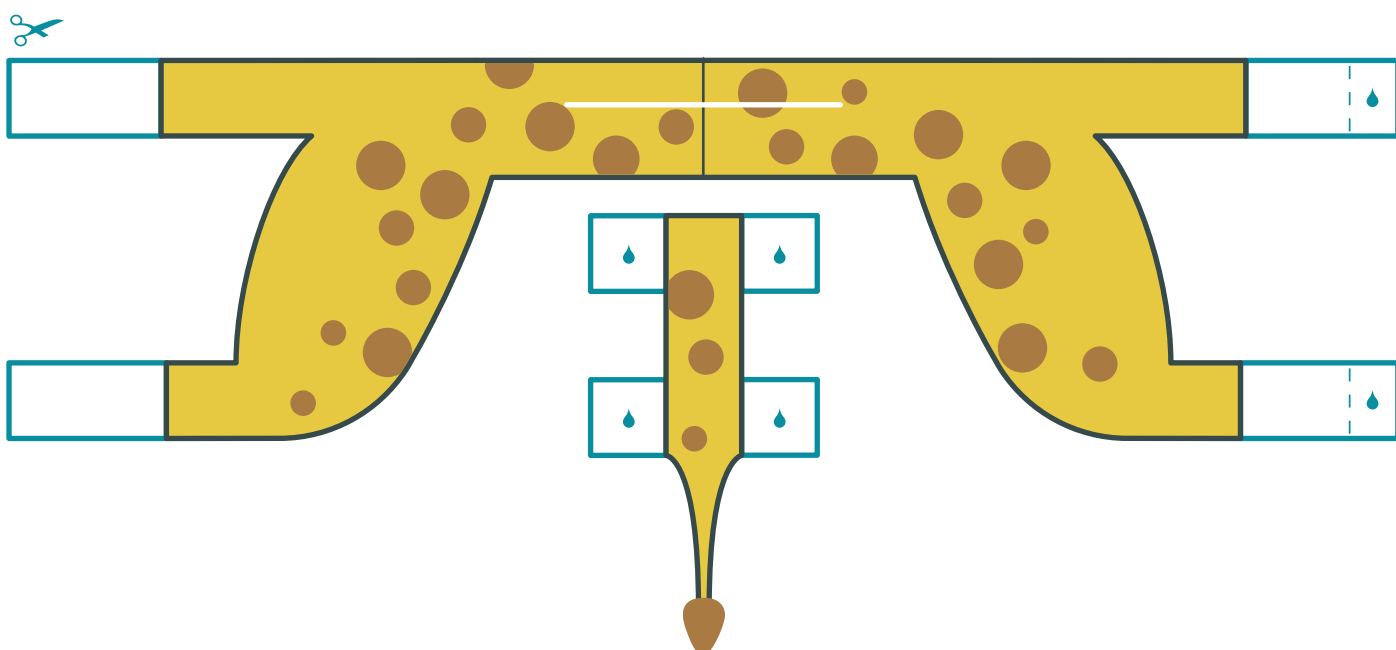
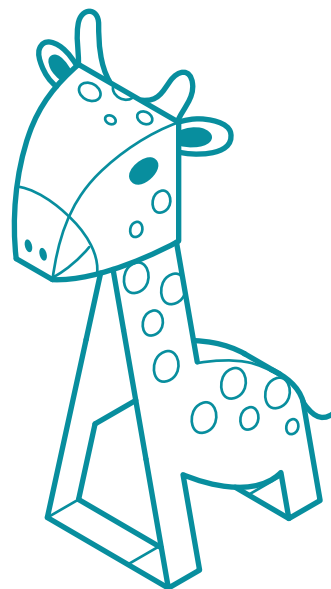

# Luie dieren – Schildpad Origami

1 vouw en ontvouw

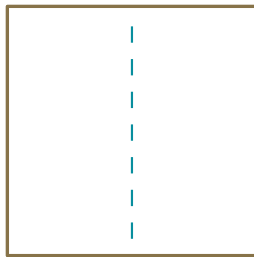

15 x 15 cm

2 vouw beide punten naar het midden

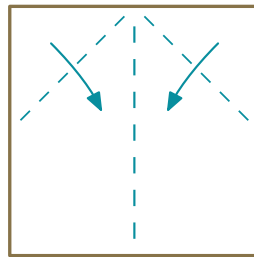

3 vouw zijkanten naar het midden, maar laat de punten naar buiten

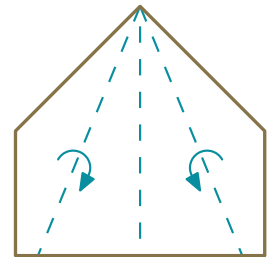

4 vouw de bovenste punt omlaag

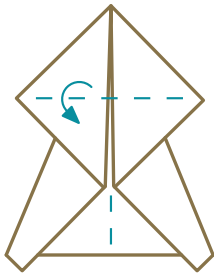

5 vouw de punt omhoog om de kop te vormen

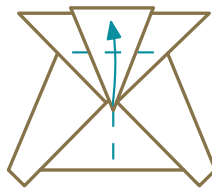

6 vouw omhoog zodat de onderrand tegen de middenvouw komt

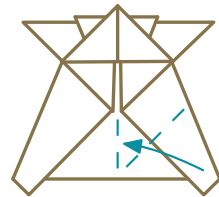

7 vouw naar buiten

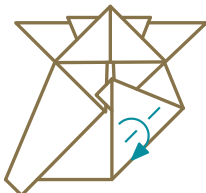

8 vouw omhoog zodat de onderrand tegen de middenvouw komt (= stap 6, maar nu links)

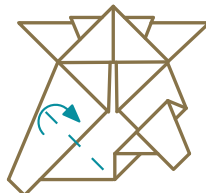

9 vouw naar buiten (= stap 7, maar nu links)

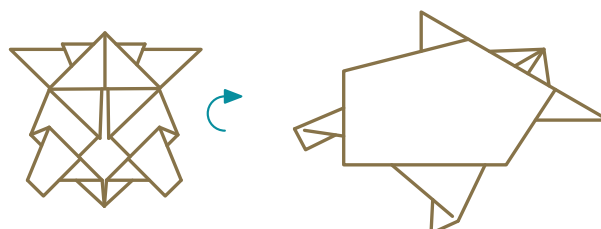
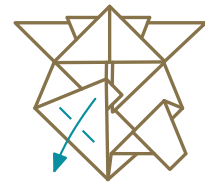

## Luie dieren – Koe Knip

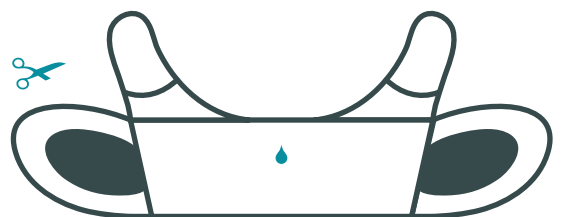
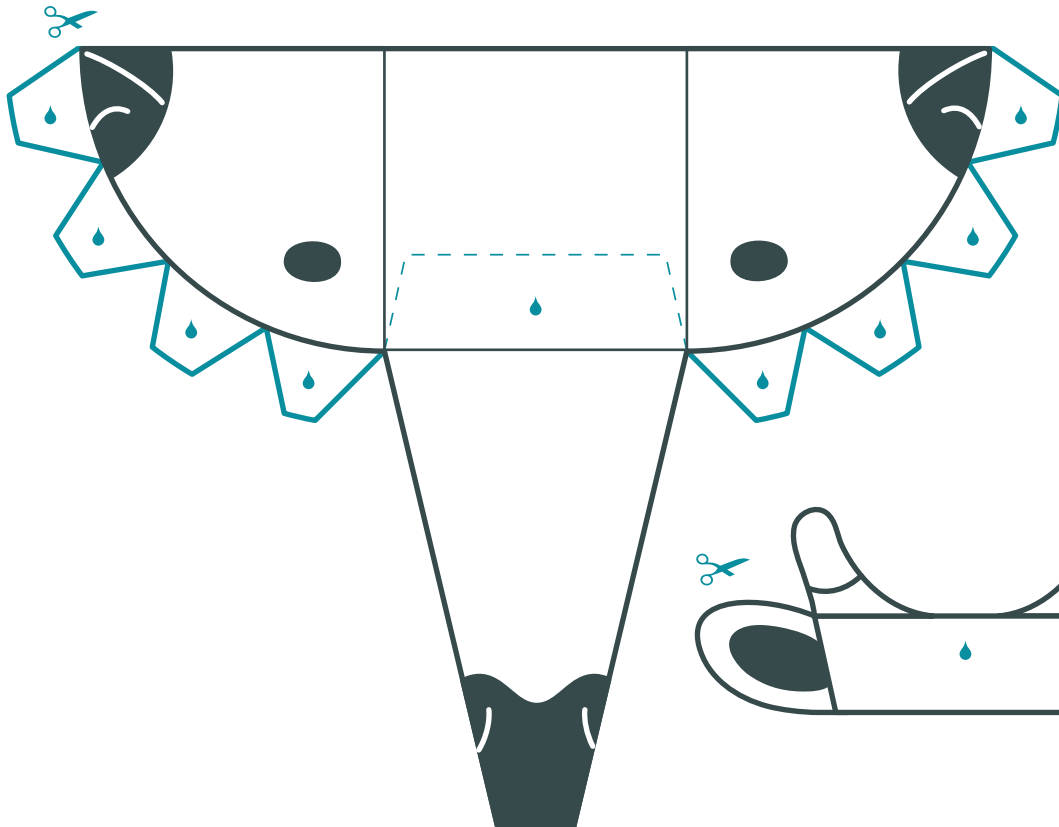
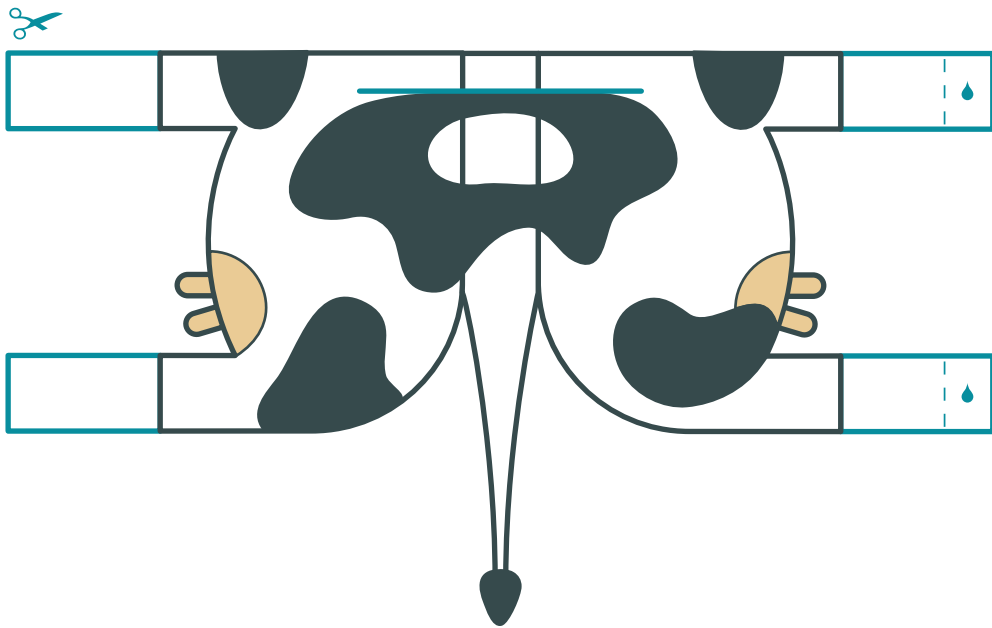
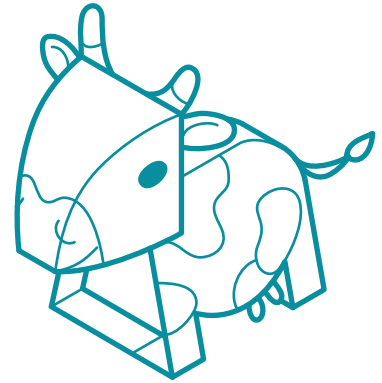

## Scherpe tanden – Haas Origami

Losse uitknipelementen: zie pag 22

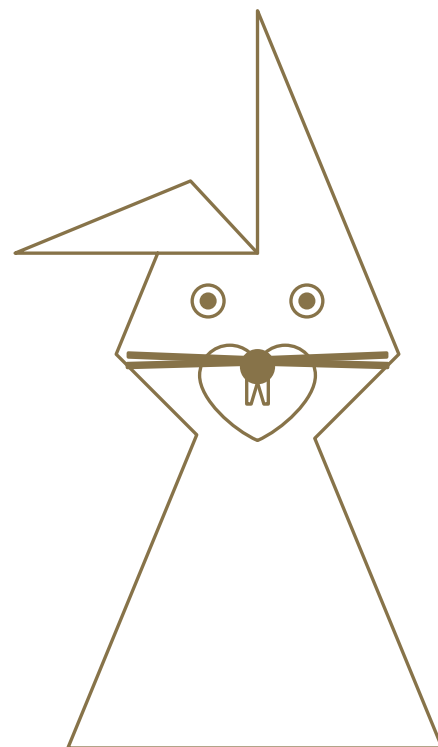
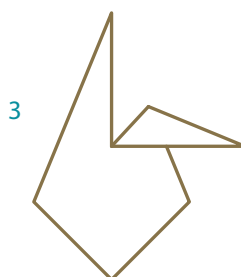
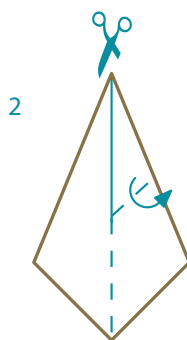
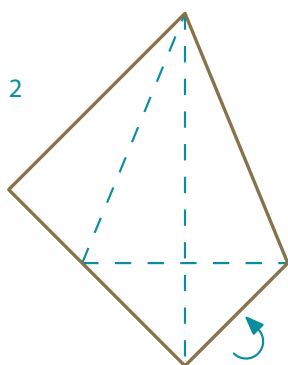
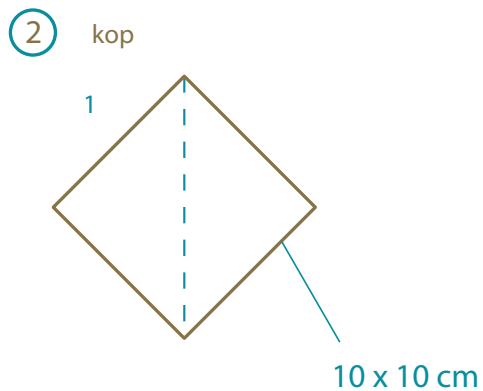
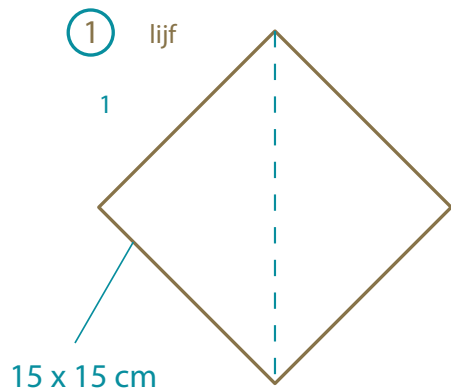



## Scherpe tanden – Leeuw Knip

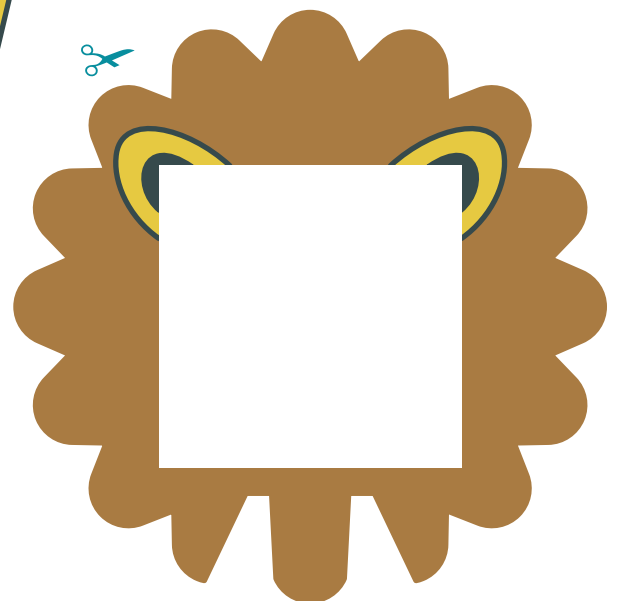
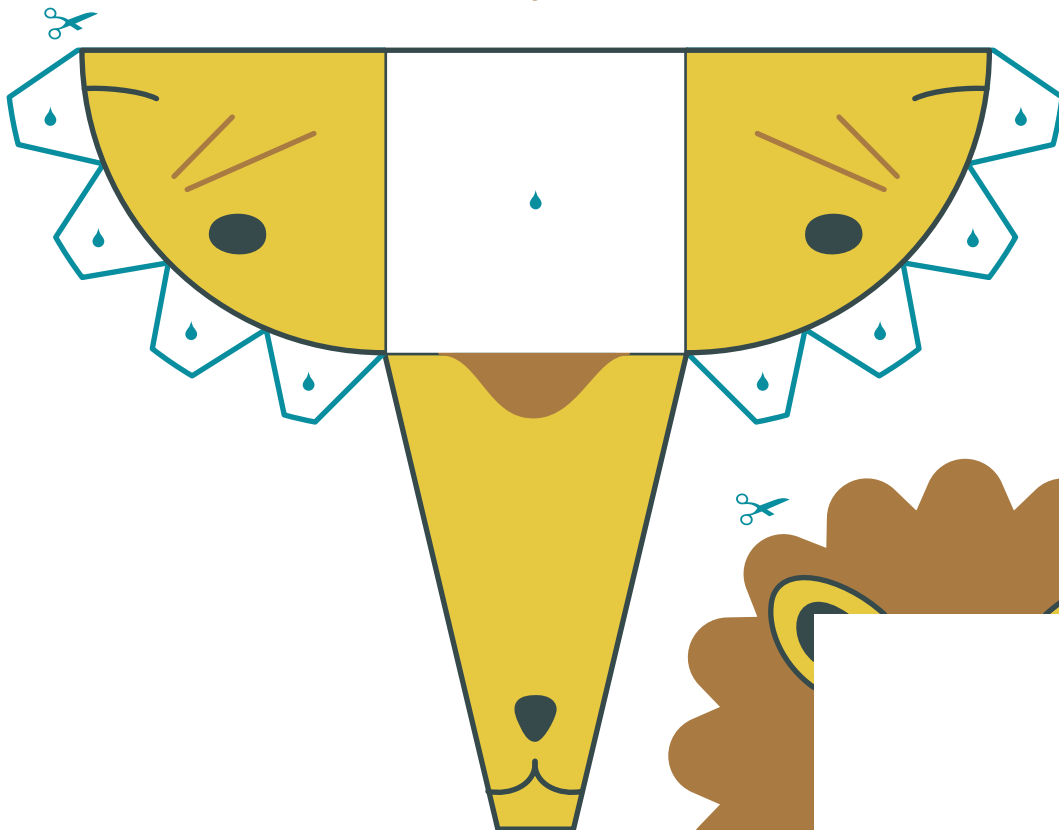
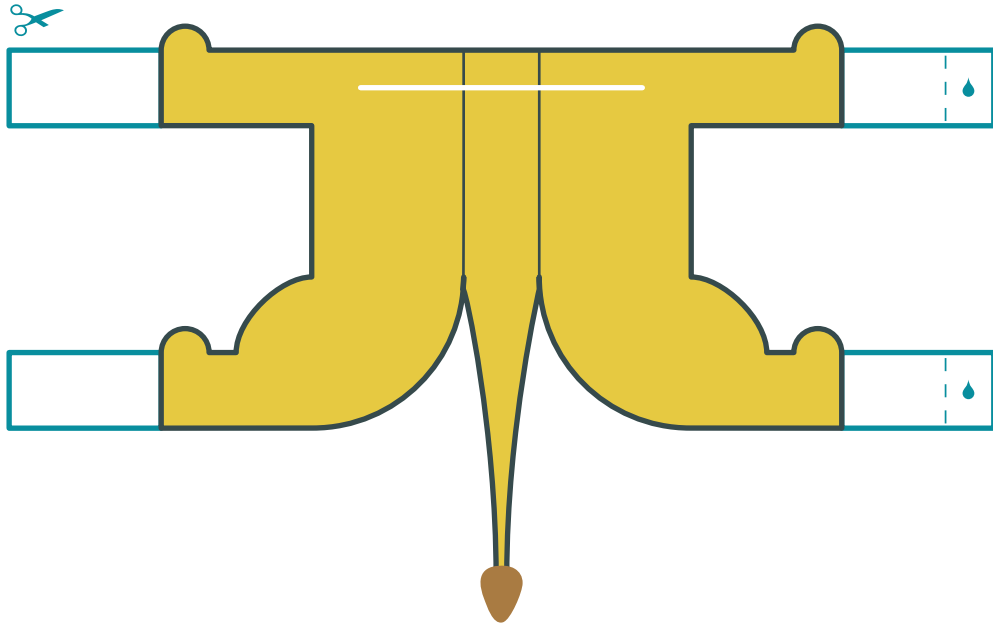

# Grijze Muizen – Muis Origami

Losse uitknipelementen: zie pag 22

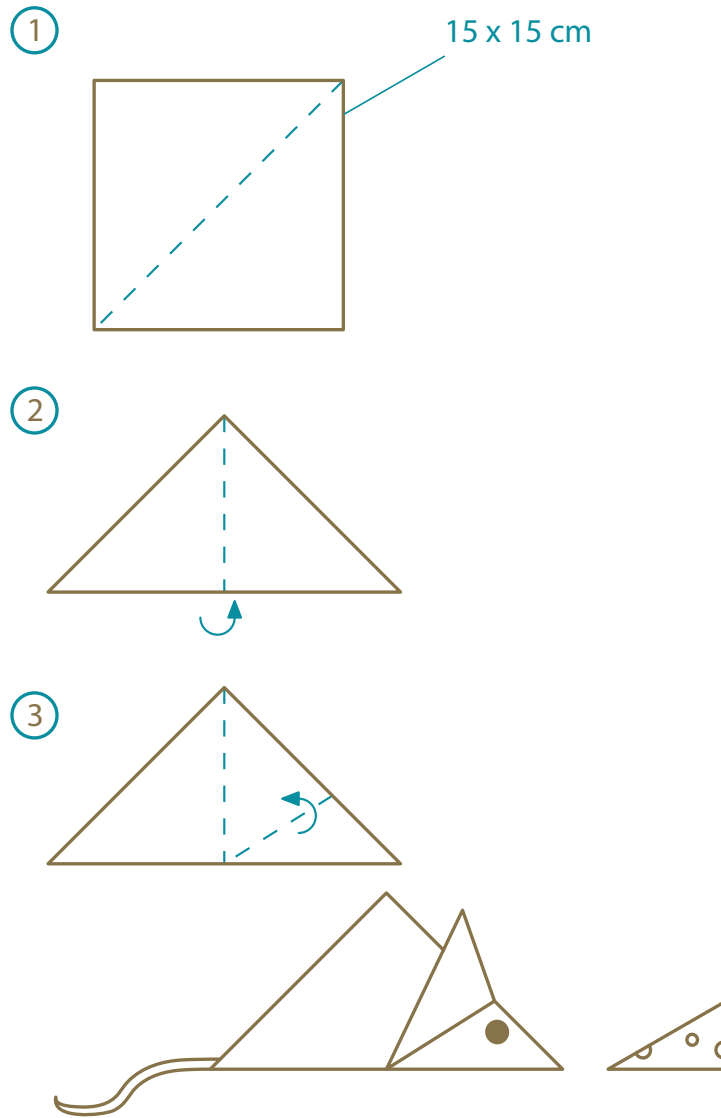

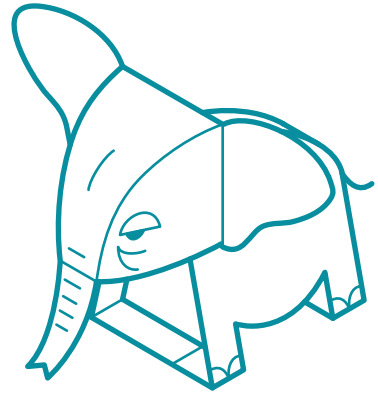

## Grijze Muizen – Olifant Knip

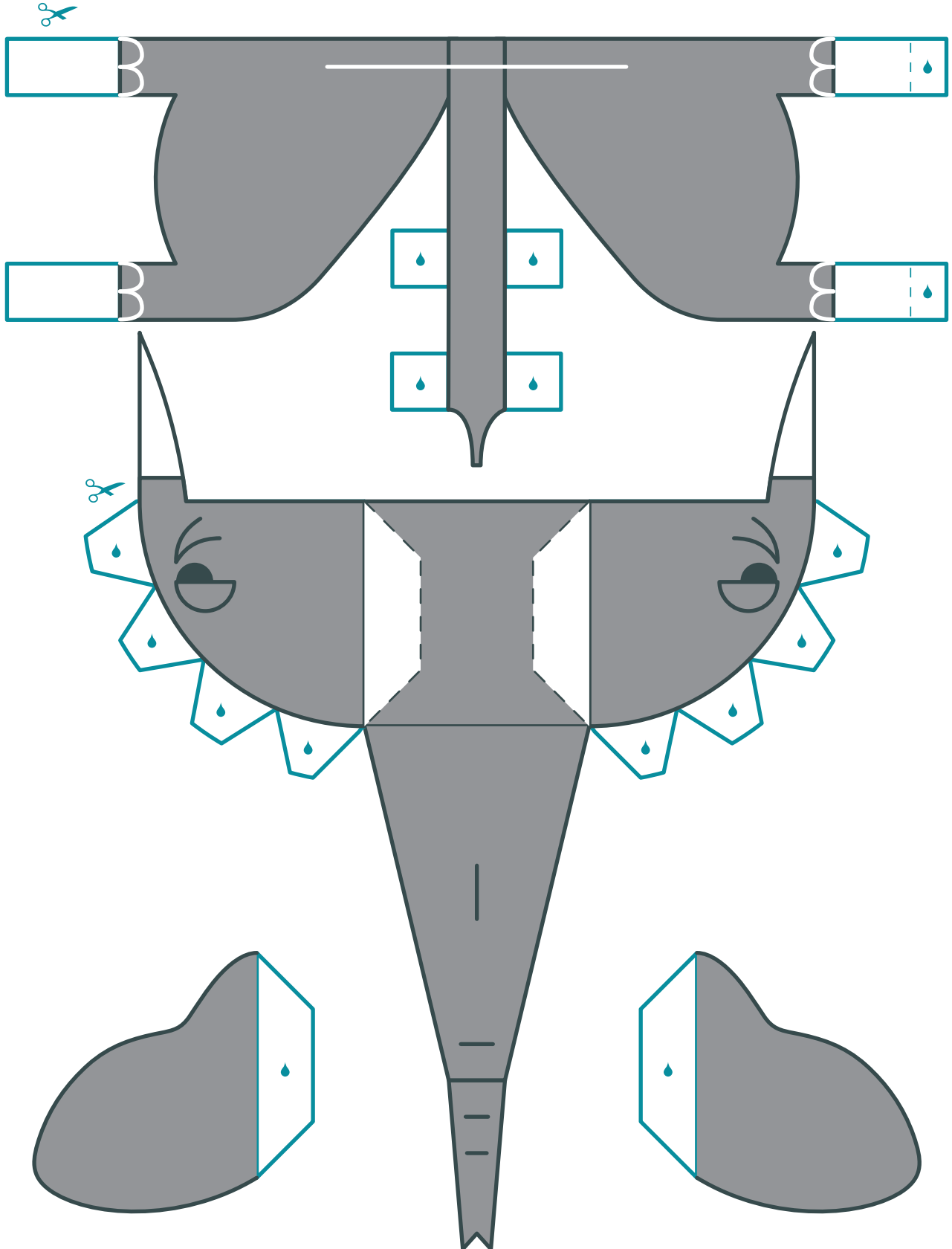

# Brulapen – Brulkikker Origami

1 vouw en ontvouw

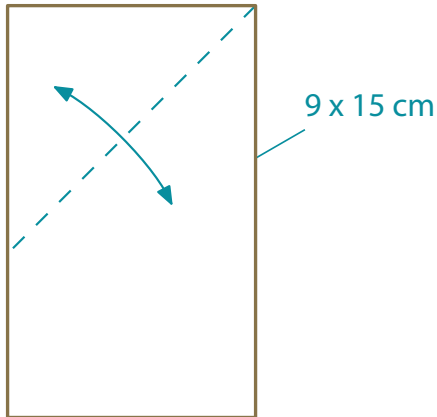

2 vouw en ontvouw

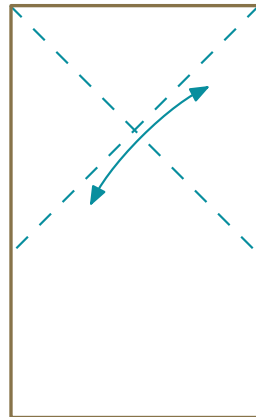

3 vouw en ontvouw

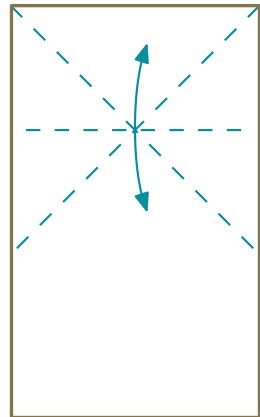

4 duw zijanten naar binnen

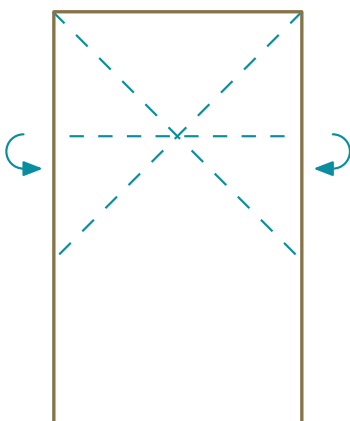

5 vouw de bovenste punten naar boven

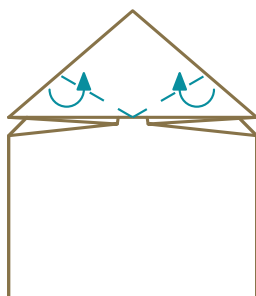

6 vouw de zijanten naar binnen

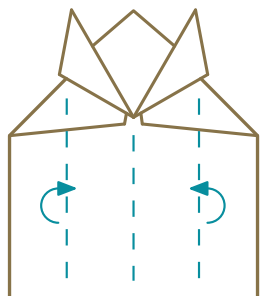

7 vouw de onderkant tegen het bovenste punt

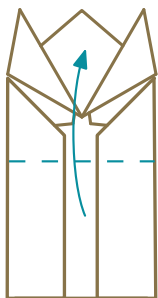

8 vouw de bovenste laag naar beneden

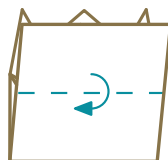

9 geef een korte tik en hup, daar gaat de kikker

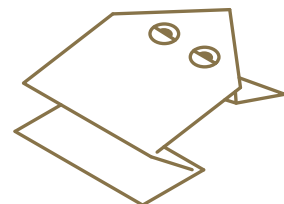

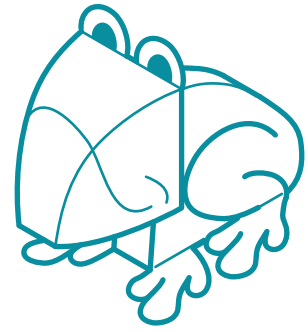

## Brulapen – Kikker Knip

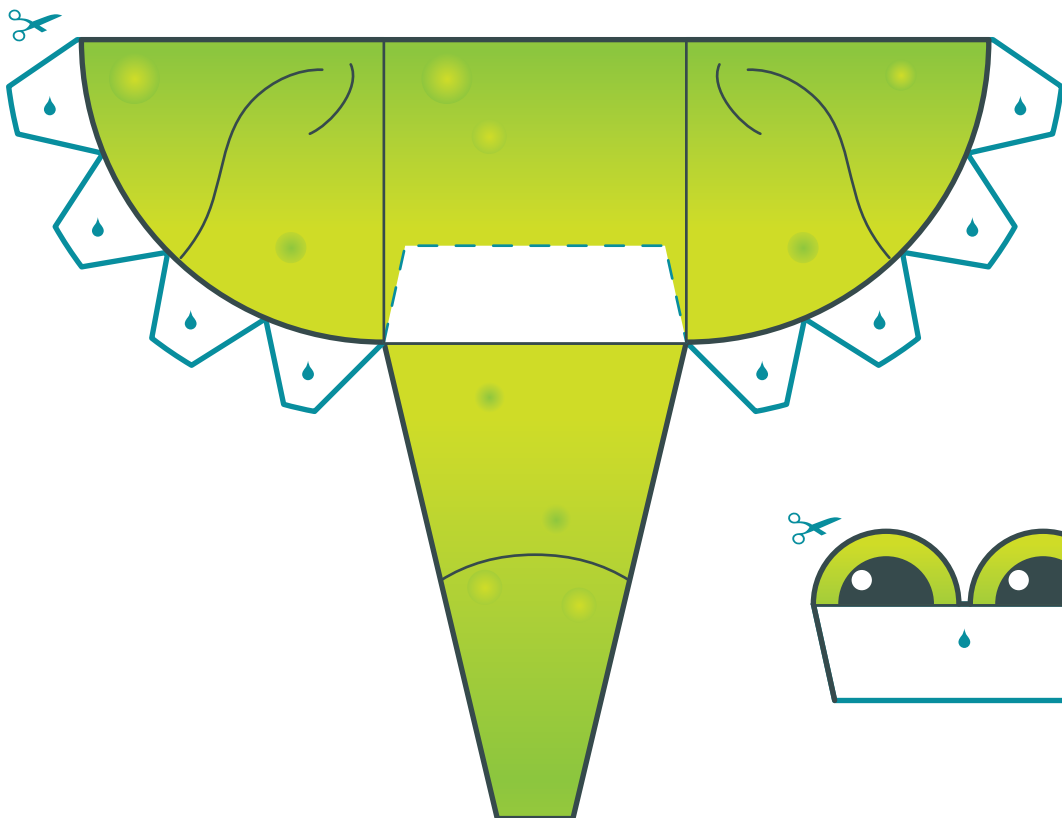
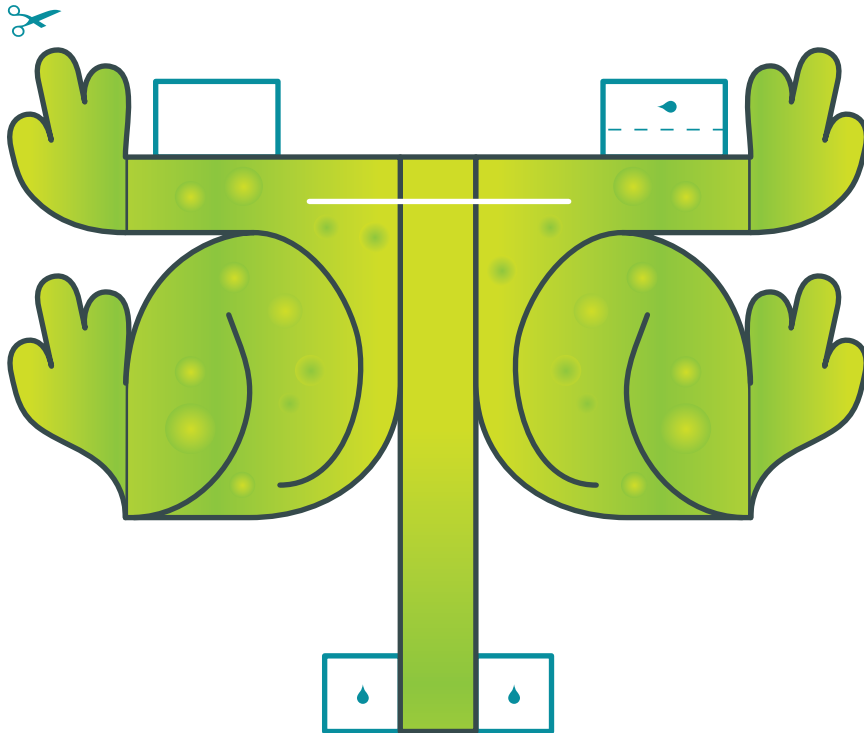

# Poten & Oren

① haas

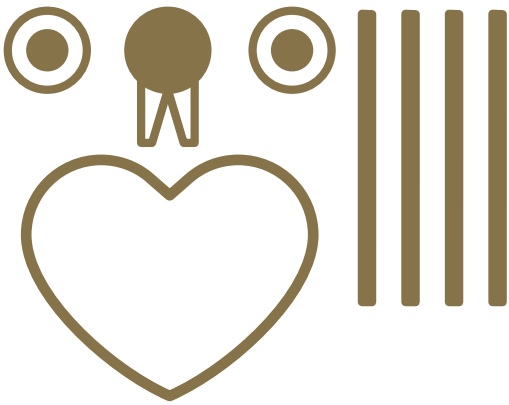

② kip

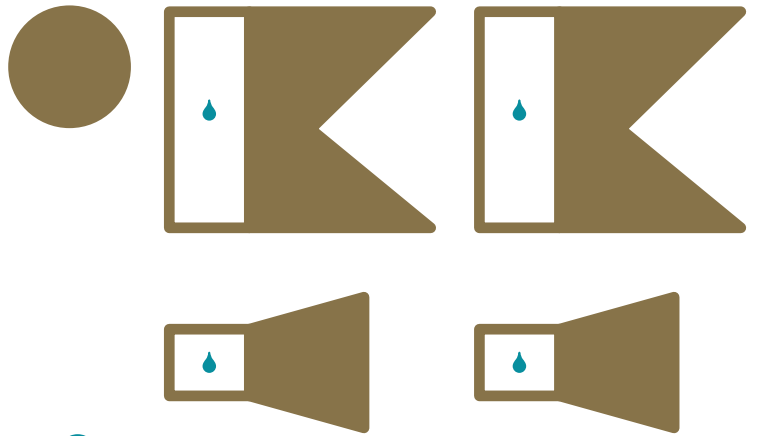

③ kat



④ pinguin



⑤ muis



⑥ slak

